



PLEASE RESPECT YOUR ENVIRONMENT!

Take care to dispose of this product and any packaging or literature in an appropriate way

#### WHAT IS A PROGRAMMER?

...an Explanation for Householders (as recommended by the Energy Savings Trust)

Programmers allow you to set 'On' and 'Off' time periods. Some models switch the central heating and domestic hot water on and off at the same time, while others allow the domestic hot water and heating to come on and go off at different times. Set the 'On' and 'Off' time periods to suit your own lifestyle. On some programmers you must also set whether you want the heating and hot water to run continuously, run under the chosen 'On' and 'Off' heating periods, or be permanently off. The time on the programmer must be correct. Some types have to be adjusted in spring and autumn at the changes between Greenwich Mean Time and British Summer Time. You may be able to temporarily adjust the heating programme, for example, 'Override', 'Advance', or 'Boost'. These are explained in the manufacturer's instructions. The heating will not work if the room thermostat has switched the heating off. And, if you have a hot-water cylinder, the water heating will not work if the cylinder thermostat detects that the hot water has reached the correct temperature.



This product and its associated documentation and packaging are protected by various intellectual property rights belonging to Honeywell Inc. and its subsidiaries and existing under the laws of the UK and other countries. These intellectual and property rights may include patent applications, registered designs, unregistered designs, registered trade marks, unregistered trade marks and copyrights.

Honeywell reserves the right to modify this document, product and functionality without notice. This document replaces any previously issued instructions and is only applicable to the product(s) described.

This product has been designed for applications as described within this document. For use outside of the scope as described herein, refer to Honeywell for guidance. Honeywell cannot be held responsible for misapplication of the product(s) described within this document.

Manufactured for and on behalf of the Environment and Combustion Controls Division of Honeywell Technologies Sarl, Ecublens, Route du Bois 37, Switzerland by its Authorised Representative Honeywell Inc.

#### Honeywell Control Systems Ltd.

Arlington Business Park,  
Bracknell  
Berkshire  
RG12 1EB

Technical Help Desk: 08457 678999  
www.honeywelluk.com

50022737-002 A  
© 2007 Honeywell International Inc.



Honeywell



## ST9100C – User Guide

7 Day Timer, 1 channel, 3 on/off per day



This document is to be left with the user  
and forms part of a Home Information Pack

### Features

Easy to use slider and buttons combined with 'LoT™ Technology and an 'OK' button, allows you to confirm changes and stay in control.

**LoT™ Technology** provides you with informative 'on-screen' feedback and operational assistance as and when required.

**Extra Large LCD (Liquid Crystal Display) with Backlight** provides added user friendliness and clearer viewing – even in the dark.

**7-day Programmes** let you choose settings built into ST9100C for each day of the week to match your lifestyle, while maximising energy savings, or alter them to your personal settings.

**Automatic Summer/Winter Time Change** will adjust the clock forward and backward automatically when the clocks change, saving you having to change your ST9100C every time.

**Built-in Memory** holds your programme indefinitely - even if the mains power fails.

### Energy Efficiency and the Environment

Home energy use is responsible for more than ¼ of the total UK carbon emissions which contribute to climate change. Heating and hot water systems based on boilers account for ⅔ of this figure, so it is important to understand how your controls can help to maximize energy efficiency while maintaining your comfort.

Your Timer should be used in conjunction with appropriate temperature controls. In order to save energy the following general points should be observed:

1. Ensure your system contains a room thermostat and a hot water thermostat, and that both are set to appropriate temperature levels: typically 20°C for the room temperature and between 55 - 60°C for the hot water temperature.
2. Programme your heating and hot water to be off when you are not in the house. If you are concerned about possible frost damage to any exposed pipe work, it is advisable to fit a frost protection system – your installer can advise you about this.
3. Think about how you use your domestic hot water – if you have a storage system, it is not necessary to have this switched on all the time, even when you are in the house.
4. Consider the heat up times required for your central heating. Every home responds differently when the heating is switched on. Adjust the start time so that you are not cold when you get up in the morning. A shorter heat up time is required for other heating periods.
5. In the evening, when the house is up to temperature, it is often possible to switch off the heating up to an hour before you go to bed, without any noticeable reduction in comfort.

## ST9100C Controls Layout

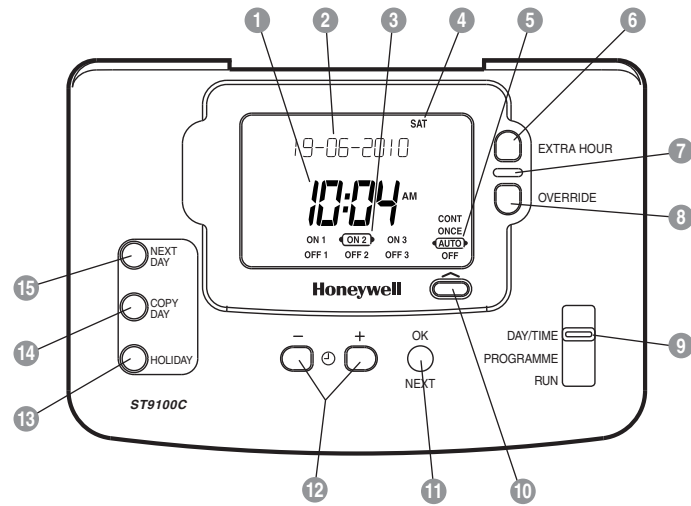

- 1 Time Display
- 2 LoT™ Technology Display
- 3 Programme Time Markers
- 4 Day of Week Indicator
- 5 Operating Mode Indicator
- 6 Extra Hour Button
- 7 Indicator Lamp
- 8 Override Button
- 9 Slider
- 10 Operating Mode Button
- 11 OK/Next Button
- 12 Clock – and + Buttons
- 13 Holiday Button
- 14 Copy Day Button
- 15 Next Day Button

## Contents

**WHAT IS A TIMER?**  
 General Description.....3  
 The way to use a Timer.....3

**GETTING STARTED WITH YOUR ST9100C**  
 Step 1: Setting the Date & Time .....4  
 Step 2: Running a Built-in Programme .....5

**PROGRAMMING YOUR ST9100C**  
 The Built-in Programmes .....6  
 Your Personal Programme .....6  
 Reviewing the Programme Times .....7  
 Modifying the Programme .....7  
   Copying one day’s Programme to another day .....8  
   Programming a Different Day.....9  
   Exiting Programming Mode .....9  
 Disabling/Enabling Time Periods .....9

**OPERATING YOUR ST9100C**  
 Choosing the Operating Mode .....10  
 Override the Operation Without Changing the Programmes.....10  
 The Extra Hour Function .....11  
 The Holiday Function.....11

**FINE TUNING YOUR ST9100C**  
 Changing From AM/PM Time display to the 24-hour Clock .....12  
 Changing the Installer Parameters .....12

**FAQ & TROUBLESHOOTING**  
 How do I set the time only, if the ST9100C clock is not correct?.....14  
 What do I do when the clocks go back in October and forward in March?. 14  
 What should I do if I get ‘lost’ while programming the ST9100C?.....14  
 What happens if there is a power failure? .....14  
 Troubleshooting Guide .....15

**CONFIGURATION & SERVICE DATA**  
 Configuration Data (to be completed by Installer) .....18  
 Boiler & System Service Log .....19

## CONFIGURATION & SERVICE DATA

### Boiler & System Service Log

The space below can be used to provide a record of boiler & system services and the names and contact numbers of the Installer and Service Personnel.

This information is important for a Home Information Pack.

Service/Installation Date	Installation/Service Engineer	Telephone Number / Contact Details

Keep this document in a Home Information Pack

## General Description

Your Honeywell ST9100C provides timing control for your central heating system, letting you set **ON** and **OFF** periods to suit your own lifestyle.

The ST9100C does not directly control the temperature but works together with other temperature controls, such as room thermostats, to control your heating system in your home.

With 7-day programming and up to 3 on/off periods per day, every day can be set differently.

The following instructions explain how to programme and use the ST9100C to provide the most home comfort at the least cost.

## The way to use a Timer

Think about the time periods when you are typically in the house and when you are not. These are the times you should use as the basis for the programmes. It will be necessary to allow some heat-up time for the heating system after periods when it has been off – this would typically be 1 - 1½ hours, depending on your house and your preferences.

Other features are commonly available on the *Timer* to enhance comfort and convenience, for example, **OVERRIDE**, **EXTRA HOUR**, and **MODE** buttons.

A typical use of the **OVERRIDE** feature is when you return home unexpectedly for the rest of the day and the heating is off. Just press the **OVERRIDE** button and the heating will come on until the next programme time, at which point it will follow the normal programme. The advantage here is that you do not have to remember to switch off because the normal time programme does this for you.

A typical use of the **EXTRA HOUR** button would be if you returned to the house for a short period when the heating was off. Pressing the **EXTRA HOUR** button gives you 1, 2, or 3 hours of heating, exactly when you need it. Another typical use is when the heating is already on and you want it to stay on a little longer - just press **EXTRA HOUR** and, for that day only, an hour will be added to the end of the time at which heating normally goes off.

The **MODE** button allows you to select how you want to operate your heating. The most obvious use is to switch heating **OFF** during the summer months, but you may also use this feature if you take a mid-week day off work, you can then set the **MODE** to **ONCE** to keep the system **ON** during the day from the first programmed **ON** time till the last programmed **OFF** time.

## GETTING STARTED WITH YOUR ST9100C

**Your ST9100C should have been set up to work correctly when it was installed. However, the following will show you how you can modify your settings to meet your particular lifestyle.**

To assist you with programming and everyday use your ST9100C will display text messages at every stage to help you get the most out of your central heating system. The ST9100C uses LoT™ Technology to constantly update the display to give you feedback about what is required.

### Step 1: Setting the Date & Time

Your ST9100C had the date and time set at the factory, and these are normally maintained by a backup battery in the event of power failures. If you wish to change the date or time, or if the LoT™ Display shows the message 'SET DATE + TIME' just follow the instructions below. Otherwise, go to **Step 2**.

- a. Move the slider to the **DAY/TIME** position. The message 'SET DATE + TIME' will show briefly on the screen, followed by 'SET THE DAY', and the day of the month will now be flashing to indicate it can be changed.

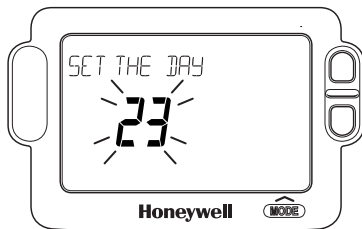
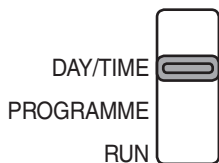

- b. To change the day of the month, press the  $\ominus$   $\oplus$  or  $\ominus$  buttons until the correct day is shown. Each press of the button will change the date by one day. As soon as a change has been made, the message 'IS DAY OK?' will be displayed. Once the correct day is reached, press the green  $\text{OK}$  button to confirm, and move to the next step. If you do not need to make a change, just press the  $\text{OK}$  button immediately and this will move you to the next step.
- c. The month digits will now be flashing and 'SET THE MONTH' will be displayed. To change the month, press the  $\ominus$   $\oplus$  or  $\ominus$  buttons until the correct month is shown. The message 'IS MONTH OK?' will be displayed. Press the green  $\text{OK}$  button to confirm the month is correct, and move to the next step.

- d. The year digits will now be flashing and 'SET THE YEAR' will be displayed. To change the year, press the  $\ominus$   $\oplus$  or  $\ominus$  buttons until the correct year is shown. The message 'IS YEAR OK?' will be displayed. Press the green  $\text{OK}$  button to confirm the year is correct. If you have made a change, and the date is a valid date, the message 'DATE SAVED' will show, and you can move to the next step. If the date you set was not valid, for example 31 September, the message 'INVALID' will show and you will be returned to the start of the date setting operation.
- e. The time will now be flashing and the message 'SET THE TIME' will be displayed. To change the time, press the  $\ominus$   $\oplus$  or  $\ominus$  buttons until the correct time is shown. Each press of the button will change the time by one minute. Holding the button down for more than a few seconds will change the time slowly at first, then quickly. The message 'IS TIME OK?' will be displayed. Press the green  $\text{OK}$  button to confirm the time is correct. If you have made a change, the message 'TIME SAVED' will show, followed quickly by 'DATE + TIME COMPLETE'.
- f. Move the slider to the **RUN** position, to complete setting the date and time.

**Note:** if the slider is moved at any time before the date and time have been set correctly, the message 'DATE UNCHANGED' will be displayed briefly, and your changes will not be saved.

## Step 2: Running a Built-in Programme

With the date and time correct, your ST9100C Timer will now be operating to the built-in programmes. These have been designed to provide heating at typical times throughout the day, but if you want to customise the settings, please see the next section '**PROGRAMMING YOUR ST9100C**' (page 6).

## The Built-in Programmes

The built-in programmes give you a starting point that you can personalise to your own requirements. Your Installer should have selected one and ticked the box alongside it. If there is no tick, the product normally leaves the factory with Profile A installed, but it is a simple matter to select one of the other profiles (see **Changing the Installer Parameters**, page 12).

**Built-in Programme (Profile A)**

	ON 1	OFF 1	ON 2	OFF 2	ON 3	OFF 3
<b>Monday to Friday</b>	6:30am	8:30am	12:00pm	1:00pm	4:30pm	10:30pm
<b>Saturday &amp; Sunday</b>	6:30am	9:30am	12:00pm	1:00pm	4:30pm	11:00pm

**Built-in Programme (Profile b)**

	ON 1	OFF 1	ON 2	OFF 2	ON 3	OFF 3
<b>Monday to Friday</b>	6:30am	9:30am	12:00pm	1:00pm	4:30pm	11:00pm
<b>Saturday &amp; Sunday</b>	6:30am	9:30am	12:00pm	1:00pm	4:30pm	11:00pm

**Built-in Programme (Profile C)**

	ON 1	OFF 1	ON 2	OFF 2	ON 3	OFF 3
<b>Monday to Friday</b>	6:30am	7:30am	12:00pm	12:00pm	5:00pm	10:00pm
<b>Saturday &amp; Sunday</b>	8:30am	9:30am	12:00pm	1:00pm	5:30pm	10:30pm

## Your Personal Programme

The table below has been left blank for you to record your own personal programme.

	ON 1	OFF 1	ON 2	OFF 2	ON 3	OFF 3
<b>Monday</b>						
<b>Tuesday</b>						
<b>Wednesday</b>						
<b>Thursday</b>						
<b>Friday</b>						
<b>Saturday</b>						
<b>Sunday</b>						

## Reviewing the Programme Times

To review your programme, move the slider to the **PROGRAMME** position.

To review the programme times, press the **OK** button repeatedly. The appropriate **ON** and **OFF** markers will be displayed to show you which time is being reviewed. Any of these times can be adjusted by using the **+** or **-** buttons, and then confirmed using the **OK** button. Remember to return the slider to the **RUN** position after reviewing is complete.

## Modifying the Programme

The programme has three pairs of **ON/OFF** switching times per day. Each time can be set between 3.00 am and 2.50 am (on the next day) to allow you to programme the system to stay on past midnight, if required.

- Move the slider to the **PROGRAMME** position. 'SET PROGRAMME' will show briefly to verify this action.



- 'SET ON-TIME 1' will then be displayed and the time setting for the first **ON 1** time for **MONDAY** will now be flashing to indicate it can be changed. If you do not wish to change the time, press the green **OK** button and move to the next step. If you do wish to make a change, use the **+** or **-** buttons to change the first **ON 1** time. Each press of the button will change the time by 10 minutes. As soon as the time has been changed, the message 'ON-TIME 1 OK?' will be displayed. Press the green **OK** button to confirm the time is correct and move to the next step. 'SAVED' will be displayed for a moment to confirm that any change has been saved to memory.

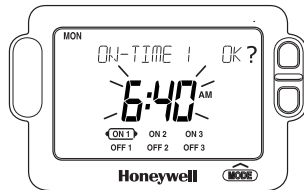
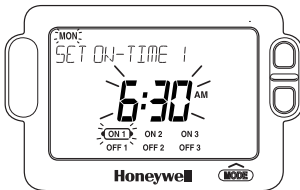

## PROGRAMMING YOUR ST9100C

**Note:** When pressing the **+** button the next **ON** or **OFF** marker may start to flash. This indicates you have tried to set a time equal to one of the next programme times already in the memory. Similarly, when pressing the **-** button the previous **ON** or **OFF** marker may start to flash. This indicates you have tried to set a time equal to one of the previous programme times. If this happens the ST9100C simply moves both times together as long as you continue to press the **+** or **-** buttons. Follow the procedure in '**Reviewing the Programme Times**' (page 7) to check and adjust these times as necessary.

- c. 'SET OFF-TIME 1' will be displayed and the first **OFF 1** time will now be flashing. If you do not wish to change the time, press the green **OK** button and move to the next step. Otherwise, use the **+** or **-** buttons to change the time. Press the green **OK** button to confirm the time is correct and move to the next step. 'SAVED' will be displayed for a moment to confirm that any change has been saved to memory.
- d. The remaining **ON** and **OFF** times (ON 2, OFF 2, ON 3, OFF 3) can be set by using the **+** or **-** buttons to change the time, and the green **OK** button to confirm the time is correct and move to the next step. If you do not wish to change the time, just press the green **OK** button to move directly to the next **ON/OFF** time without making any changes.
- e. After setting or reviewing the last off time, **OFF 3**, the message 'COMPLETE' will be displayed to indicate the times for Monday have been set.

You now have a choice of how to set the programme for the next day:

### **Copying one day's Programme to another day (example Monday to Tuesday):**

- f. Whilst the day is showing Monday, Press the **COPY DAY** button. The message 'COPY MON TO TUESDAY OK?' will be displayed and the letters **TUE** will flash to indicate the programme for Monday can be copied to Tuesday.
- g. To select a different day to copy to, press the **NEXT DAY** button to cycle through the days. With each press of the **NEXT DAY** button the message will change to indicate the new day you are copying to.



- h. When the required day is indicated, press the green **OK** button to confirm, and the message 'MON COPIED' will be displayed for a moment. The day into which Mondays programme has been copied is now available to have its programme edited.

**Note:** Once a day's programme has been confirmed in this way, it now becomes the day whose programme is copied if the **COPY DAY** button is pressed again.

**OR**

#### **Programming a Different Day:**

- i. Press the **NEXT DAY** button to select the next day, which is displayed along the top of the screen. The programme for that day can then be adjusted by following steps **b – e** above. Programmes for the remaining days can be set in the same way, using the **NEXT DAY** button to move to the next day.

#### **Exiting Programming Mode:**

To exit programming mode, move the slider to the **RUN** position. This can be done at any time during the programming process, and any changes made and confirmed with the **OK** button will have been saved.

**Note:** If the unit is left in programming mode for more than 10 minutes without the slider being moved or any buttons pressed, the message 'MOVE SLIDER' will be displayed. Press a button to finish programming, or move the slider to the **RUN** position.

#### **Disabling / Enabling Time Periods**

To disable any of the time periods **ON 1** to **OFF 1**, **ON 2** to **OFF 2**, or **ON 3** to **OFF 3**, simply set the **ON** time and its paired **OFF** time to the same time, and the programme will just ignore them.

To re-enable the time period, simply set the two **ON** and **OFF** times to be different.

### Choosing the Operating Mode

The operating mode may only be changed when the slider is set to the **RUN** position.

A green **INDICATOR LAMP** shows when the system is switched **ON**.

A **MODE** button is provided to select the Operating Mode and therefore how the system is controlled.

There are four possible **Operating Modes**; these are **OFF**, **AUTO**, **ONCE**, **CONT**. Pressing the **MODE** button scrolls round these modes in sequence, and the display indicates which mode is currently active.

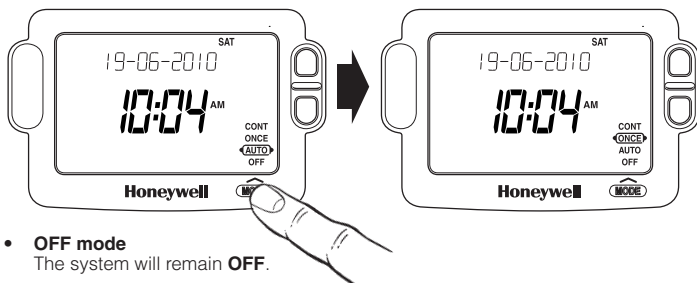

- **OFF mode**  
The system will remain **OFF**.
- **AUTO (Automatic) mode**  
The system will be switched **ON** and **OFF** according to the programme.
- **ONCE mode**  
The system will come **ON** at the first programmed **ON** time, and go **OFF** at the last programmed **OFF** time.
- **CONT (Continuous) mode**  
The system will remain **ON** continuously.

### Overriding the Operation Without Changing the Programmes

In **AUTO** and **ONCE** operating modes, the **OVERRIDE** button switches the system **ON** or **OFF** without altering the programme.

When the indicator lamp is **ON**, pressing the **OVERRIDE** button switches the system **OFF** until the next programmed **ON** time.

When the indicator lamp is **OFF**, pressing the **OVERRIDE** button switches the system **ON** until the next programmed **OFF** time.

The LoT™ Display will provide you with information about the override.

## The Extra Hour Function

The **EXTRA HOUR** button allows you to switch the system **ON** for up to 3 extra hours without altering the programme. Pressing the button once will give one extra hour. The LoT™ Display will display the message '+ 1 HOUR', to confirm the button has been pressed.

When the green **INDICATOR LAMP** is **OFF**, pressing the **EXTRA HOUR** button switches the system **ON** for just one hour.

When the green **INDICATOR LAMP** is **ON**, pressing the **EXTRA HOUR** button extends the programmed **ON** period by one hour.



Further presses of the **EXTRA HOUR** button will increase the extra hour period by one hour for each button press, up to a maximum of 3 hours. The LoT™ Display will continue to provide information on the extra hour status.

To cancel the extra hours, just keep pressing the **EXTRA HOUR** button until the 'CANCELLED' message appears on the LoT™ Display.

## The Holiday Function

The Holiday function allows you to switch off your system for a specified number of days (from 1-99 days). This lets you save energy and related costs when you are away from home, but resumes normal operation on the day of your return.

### To set the Holiday function:



- Ensure the slider is in the **RUN** position, then press the **HOLIDAY** button once. The message 'SET HOLIDAY' will appear briefly, followed by 'SET DAYS AWAY'.
- Use the  or  buttons to set the number of days you will be away. The display will show the number of days, and this number will be flashing to indicate it can be changed. The day of the week will also keep changing to show the day you return.
- If you have made a change to the number of days, the message 'DAYS AWAY OK ?' will appear. Press the green  button to confirm your selection.
- The message 'SAVED' will be displayed for a few seconds, followed by the date you return, to enable you to check you have programmed the holiday function correctly.
- During the holiday period, the LoT™ Display will show the message 'ON HOLIDAY' and the display will count down the number of days till you return.

### To cancel the Holiday function:

- To cancel the Holiday function, just press the **HOLIDAY** button again. The LoT™ Display will show 'CANCELLED' and the unit will return to normal operation.

**Note:** while setting the Holiday function, if there is a gap of more than 1 minute between button presses, the function will cancel itself automatically and return to normal operation.

## Changing from AM/PM Time Display to the 24 Hour Clock

Your ST9100C can operate on the 12 hour AM/PM or 24 hour clock formats. To change the format, ensure the slider is in the **RUN** position then press and hold the  and  buttons together for about 2 seconds. Ignore the 'NOT VALID' message that will appear briefly. All the displayed times will be automatically changed to the new format.

Repeating this procedure will change the clock display back to the original format.

## Changing the Installer Parameters

The ST9100C has a special Installer Mode where some features can be adjusted to suit your lifestyle or preferences – these are called Installer Parameters, and are listed in the table below, along with a description of the options that are possible.

INSTALLER PARAMETER	Parameter Number	Default Value	Options	Description
24hr or am/pm clock display.	1	12	12, 24	12 = am/pm display, 24 = 24hr display
Configure backlight operation.	2	2	0, 1, 2	0 = off, 1 = on if button pressed, 2 = on continuously
Enable/disable auto time change.	3	1	0, 1	0 = disabled, 1 = enabled
1-day or 5/2-day or 7-day operation.	4	7	1, 5, 7	1 = 1-day operation, 5 = 5/2-day operation, 7 = 7-day operation
Number of ON/OFFs per day.	5	3	2, 3	2 = 2 on/off per day, 3 = 3 on/off per day
Select default time programme.	6	A	A, b, C	A = standard, b = at home, C = economy
Reset all parameters	8	1	0, 1	0 = do not reset 1 = default parameters

**To Enter Installer Mode:**

- a. Ensure the slider is in the **RUN** position, then press and hold **OK** and **-** buttons together for 8 seconds. Ignore the 'NOT VALID' message that is displayed for a few seconds. The message 'SET UP MENU' will show briefly, followed by 'SET INSTALLER OK ?'
- b. Press the **OK** button to take you into the Installer Mode Parameter Menu.
- c. Parameter 1 is now available to change. This is to allow you to change the clock format from 12 hour AM/PM to 24 hour. At every step, the LoT™ Display will inform you what the parameter means and what option you have selected. The parameter number is shown on the display separated by a colon from the parameter value.
- d. You can change the parameter value by pressing the **+** or **-** buttons. At this point the description in the LoT™ Display will change and the parameter value will flash. If you press **OK** the value will stop flashing and be saved for use.
- e. Press **OK** to move to the next parameter available for editing.
- f. Keep pressing **OK** to step around the list of parameters, and use **+** or **-** buttons to change the parameter value.
- g. Any parameter changes that have been confirmed with the **OK** button will be saved and used.

**To Exit Installer Mode:**

- h. You can exit Installer Mode at any time by moving the slider to the next position and then back again to **RUN**.

**Note:** Installer Mode will exit automatically after 10 minutes if the slider is not moved.

### How do I set the time only, if the ST9100C clock is not correct?

Your ST9100C contains a very accurate digital clock that is factory pre-set. Should you ever need to change the time, just follow this procedure:

- a. Move the slider to the **DAY/TIME** position.
- b. Keep pressing the green **OK** button until the message 'SET THE TIME' is displayed. To change the time, press the **+** or **-** buttons until the correct time is shown. The message 'IS TIME OK?' will be displayed. Press the green **OK** button to confirm the time is correct. If you have made a change, the message 'TIME SAVED' will show, followed quickly by 'DATE + TIME COMPLETE'.
- c. Move the slider to the **RUN** position, to complete changing the time.

### What do I do when the clocks go back in October and forward in March?

Your ST9100C is factory-set to adjust the clock automatically at the correct dates, so you should never need to adjust the clock forward or backwards yourself. It is possible to disable this particular feature, as described in the section '**Changing the Installer Parameters**' (page 12). You may also check the section '**Configuration & Service Data**' (page 18) to see how your Installer has configured your product.

### What should I do if I get 'lost' while programming the ST9100C?

The LoT™ Display on ST9100C will provide you with help and tips to work through the programming. Should you ever get 'lost', the simplest thing to do is to move the slider to the **RUN** position, and then move it back to the appropriate programming position where you got lost. At this point just follow the instructions again.

### What happens if there is a power failure?

In the event of a mains power failure, the ST9100C display will go blank, the indicator lamp will go out, and the control output will switch off. The real time will be constantly maintained by means of the built-in battery backup, ready to power back up as if nothing had happened when the mains power is restored. In addition, all programmes and settings are stored in a special memory (called NV memory) which requires no power to maintain information, and so will be retained indefinitely.

Should the correct time and date ever be lost, for whatever reason, the message 'SET DATE + TIME' will be displayed whilst the slider is in the **RUN** position. In this case, simply follow the procedure described under '**Step 1: Setting the Date & Time**' (page 4). It should not be necessary to make any changes to your programmes.

## Troubleshooting Guide

This is a quick guide to help you diagnose and cope with possible problems with ST9100C. For further assistance, please contact your Installer.

Symptom	Possible Cause	Remedy
ST9100C has a blank LCD display	No power to the system	Check that there is power to the system
	Fault in ST9100C	Call Installer
ST9100C indicates that the system is <b>ON</b> , but radiators are cold and/or taps are running with cold water.	Temperature controls are switched off or set too low	Check that the temperature controls in the system are set to appropriate levels
	Boiler or other system controls have malfunctioned	Call Installer
ST9100C shows the message 'INTERNAL FAULT'	Fault in ST9100C	Call Installer







## CONFIGURATION & SERVICE DATA

### Configuration Data (to be completed by Installer)

The table below is for the Installer to complete to indicate how your ST9100C has been configured.

Configurable Features	Options	Installer Configured (tick appropriate box)
24hr or am/pm clock display	am/pm display	<input type="checkbox"/>
	24hr display	<input type="checkbox"/>
Display backlight operation	Off	<input type="checkbox"/>
	On if button pressed	<input type="checkbox"/>
	On continuously	<input type="checkbox"/>
Automatic time change	Enabled	<input type="checkbox"/>
	Disabled	<input type="checkbox"/>
1-day or 5/2-day or 7-day operation	1-day operation	<input type="checkbox"/>
	5/2-day operation	<input type="checkbox"/>
	7-day operation	<input type="checkbox"/>
Number of ON/OFFs per day	2 on/off per day	<input type="checkbox"/>
	3 on/off per day	<input type="checkbox"/>
Default programme	A = standard	<input type="checkbox"/>
	b = at home	<input type="checkbox"/>
	C = economy	<input type="checkbox"/>