

Alpha

HEATING INNOVATION

Easy-Stat

Wireless Programmable Room Thermostat

Pt No 7.2000050

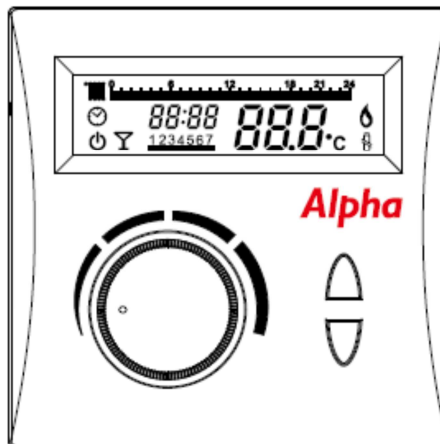

Installing the receiver

The receiver must be installed into the boiler control panel, refer to the boiler installation manual for guidance.

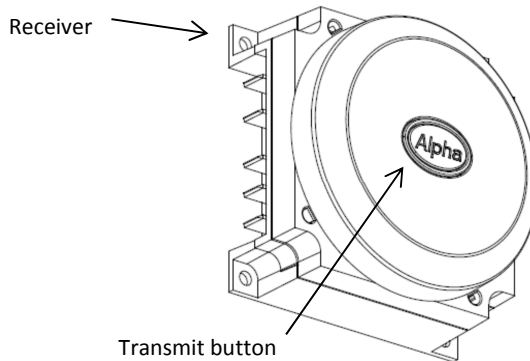

Installing the programmable room thermostat

The Alpha Easy-Stat is a programmable room thermostat and must be installed in the correct position, approximately 1.5 meters from the ground and must not be fitted in any of the following positions;

1. In direct sunlight
2. Near a heat source i.e. radiator, fire etc.
3. In an area where it can be influenced by a draught
4. Near or behind curtains or furniture

A typical location for the unit would be in a hallway or open plan living area exposed to the room temperature being controlled.

The left side of the controller must be a minimum of 100mm from a corner or obstructions to allow the replacement of the two AA type batteries. Please observe the correct polarity on the batteries when removing or replacing.

Separate the timer by pressing the top, bottom and side of the rear section and gently pull apart being careful not to pull the wires within the unit, unplug the wires from the PCB.

Fig 2.

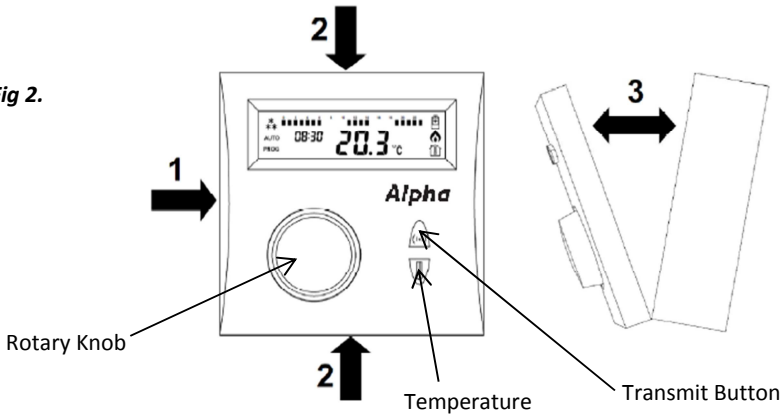

Offer the back plate in suitable location making sure it is level and a 100mm gap is maintained on the left side then mark the screw positions on the wall. Using a 5mm drill bit drill the holes in the wall and insert the wall plugs. Secure the back box into position using the screws provided. Offer the timer up to the back plate re-connecting the wire to the PCB. Push the timer into position making sure it has clicked in on each side.

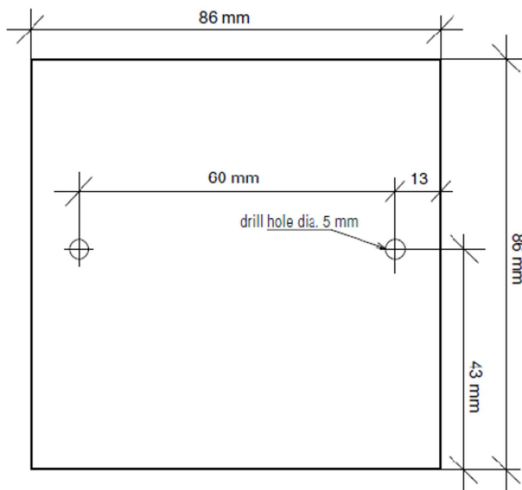



Display and Symbols





SYMBOL	DESCRIPTION & FUNCTION
	Timed heating function, according to the time periods set.
	Standby mode, heating held off (summer time)
	Party mode. heating held on to maintain the set temperature
	Override mode. Overrides the heating until next time period
1234567	Day of the week indicator
88:88	Time display
	Hourly heating time segments
88.8°C	Temperature display
	Low battery indicator
	Heating request to the boiler
ECoE	Economy Temperature. Minimum temperature during off periods.
EXIT	Exit program menu

Commissioning Procedure

The controller is supplied pre-commissioned (paired to the receiver). Should the timer need to be paired to a new receiver then the following procedure must be followed.

1. Press the transmit button  on the receiver for 5 seconds and the light will flash.
2. Press the transmit button  on the timer for 5 seconds and the timer will pair with the receiver, indicated when the receiver light stops flashing.
3. Press the rotary knob (see fig 2) to exit the procedure.



Setting the room temperature (Set temperature)

Turn the rotary knob to the desired room temperature  and press the temperature button  to store the required set temperature for the heating on periods. The display will then revert back to the current room temperature.

It is possible to view the stored set temperature by pressing the temperature button , during an on period the set temperature will be shown and during an off period the ECO temperature will be shown. If in override the requested override temperature will be shown.

Setting the working mode



The timer has three working modes that can be selected by pressing the transmit button .



1. **Off.**  The heating is switched off
2. **Timed.**  The heating is controlled by the user defined time periods
3. **Party.**  The heating is on constant

Setting the time / day and heating programs

Press the rotary knob for 5 seconds and the hour will flash. Press again and the hour will be displayed, rotate the knob to adjust to the correct hour and press the knob to store (24h). Rotate the knob and the minutes will flash. Press again and the minutes will be displayed, rotate the knob to adjust to the correct minutes and press the knob to store.

Rotate the knob again and the days of the week will flash , press the knob and the days of the week will be displayed, turn the knob to scroll to the correct day of the week (1 being Monday) and press the knob to store.

Turn the knob again to access the heating on/off settings. The days from 1 to 5 will be underlined **1234567** (Monday to Friday), press the knob to enter the heating on/off time periods. The display will show a graph at the top | ■■■■¹⁸ representing each hour of the day and the time from midnight, turn the knob to scroll through the hours of the day and press the transmit button  to select an on period, this will be identified by a solid block in the graph for each hour selected. To remove a selected on period press the temperature button  and the solid block will disappear. Press the knob to store the settings.

Turn the knob and 6 and 7 will be underlined **1234567** (Saturday and Sunday), press the knob to enter the heating on/off time periods. The display will show a graph at the top | ■■■■¹⁸ representing each hour of the day and the time from midnight, turn the knob to scroll through the hours of the day and press the transmit button  to select an on period, this will be identified by a solid block in the graph for each hour selected. To remove a selected on period press the temperature button  and the solid block will disappear. Press the knob to store the settings.

Turn the knob and day one will flash; this gives the option to set different heating on/off periods for individual days if required **1234567**. To set each day follow the procedure above for each day. If different individual day settings are not required turn the knob through each day to skip to the next function.

After the heating on/off periods are set turn the knob and **EC Dt** will be displayed, this represents the minimum room temperature setting during a heating off period. Press the knob to enter the menu and turn the knob to adjust the temperature to the desired setting (e.g 14°C), press the knob to store.

Turn the knob and **EH! t** will appear, press the knob to exit the programming menu. Alternatively it will automatically exits after 1 minute.

Temporary Override Function

The heating can be overridden at any time during an on or off period by turning the knob to the desired temperature and pressing the knob to accept. The controller will maintain this set temperature until the next time period is reached. To exit the override function before the next time period press the transmit button .

Parameter settings

Frost Protection

Frost protection will switch the heating on should the room temperature fall below the temperature set (e.g. 4°C) to help prevent pipes from freezing.

Press the temperature button  for 5 seconds and FrSt 01 will appear, press the rotary knob to enter menu and the temperature will appear. Turn the knob to set the temperature and press the knob to store.

Heating off

This setting controls the switch off point for the heating to maintain an even temperature e.g. if the set temperature is 20°C and the heating off setting is 0.6, the heating will switch off when the room temperature reaches 20.6°C.

Turn the knob to HOFF 02, press the knob and the temperature will be displayed, turn the knob to adjust the temperature and press the knob to store.

Heating on

This setting controls the temperature at which the heating is switched back on after the set temperature is reached e.g. if the temperature is set to 20°C the heating will be held off until the room temperature falls by the amount set. For example; a 0.5°C setting means that the heating will switch on when the temperature falls to 19.5°C.

Turn the knob to H On 03, press the knob and the temperature will be displayed, turn the knob to adjust the temperature and press the knob to store.

Room Temperature Sensor Calibration

Turn the knob to CALI 04; press the knob to enter menu and the temperature will appear. It is now possible to turn the knob to adjust the calibration of the temperature sensor. **Note; this must be set using an accurate thermostat for comparison.** When the temperature is set, press the knob to store.

Low Battery Override

When the batteries in the controller eventually lose their charge and the controller stops working the heating can be switched on and off manually by pressing the button on the receiver. In this mode the receiver will switch on the heating constantly and maintain the flow temperature set by the boiler thermostat, pressing the receiver button again will switch the heating off. It is recommended to fit new batteries as soon as possible.

TECHNICAL SPECIFICATIONS

RECEIVER

Linked with transmitter via RF: frequency 868 MHz

Power rating: 230 VAC \pm 10%, 50 Hz

Power consumption: 1.2 W

Relay switching capacity: Max 1A at 230 VAC

TRANSMITTER

Linked with receiver via RF: frequency 868 MHz

Power rating: 2 x 1.5AA - Alkaline batteries

Temperature setting: 3°C to 35°C in 0.2°C increments.

Display temperature: -9.9°C to 50°C in 0.2°C increments.

ErP Directive Commission Delegated Regulation (EU) No 811/2013

This Temperature control device complies with Class 1 of the ErP directive.

A value of 1% should be applied to the heating system assembly chart.

Approved for use: CE, LVD and EMC

EASY – STAT inst 0515 rev 03