

9052 BATH FILLER



PRODUCT SPECIFICATION

Product Code: 9052
Finish: Chrome
Product Type: Bath Filler
Inlet Connections: 3/4 BSP
Construction: Body: Brass
 Handles: Zinc
Gross Weight (kg): 2.97



ADDITIONAL INFORMATION

- Chromed finish
- Lifetime guarantee

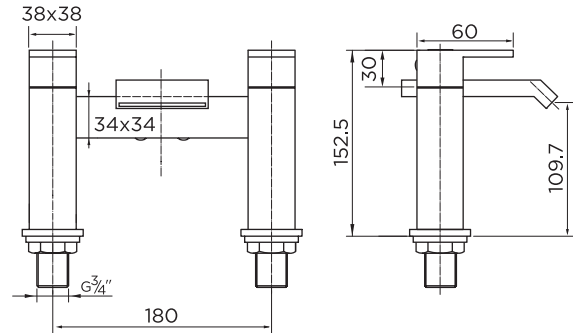

WORKING PRESSURES (bar)

Min Pressure	Max Pressure	Best Performance
0.2	6	3

FLOW RATES (litres per minute)

0.5 Bar	1 Bar	3 Bar
3.9	7.6	13.2

